



Lighting Design
LED Lights

Since 2004

Wall Lights Catalogue



WALL LIGHTS

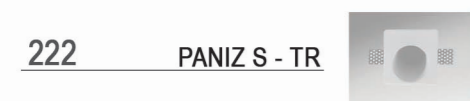
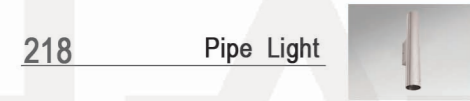

FLP-09W

WALL SURFACE
UP/DOWN LIGHT

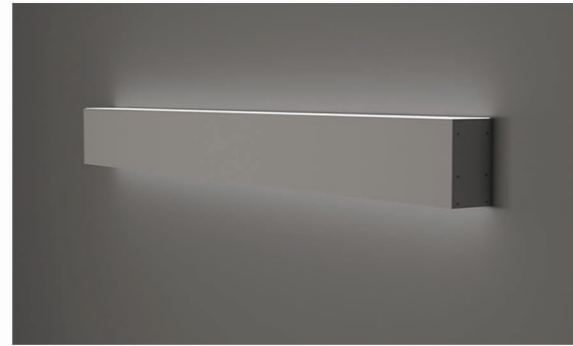

Dimension

Length	Width	Heights
Up To 2800mm	63mm	130mm

CCT

3000K
4000K
TW

Section

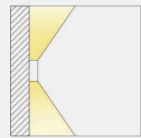

Finish

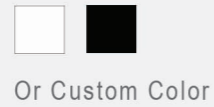

Installation

Wall Surface

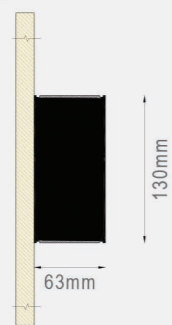

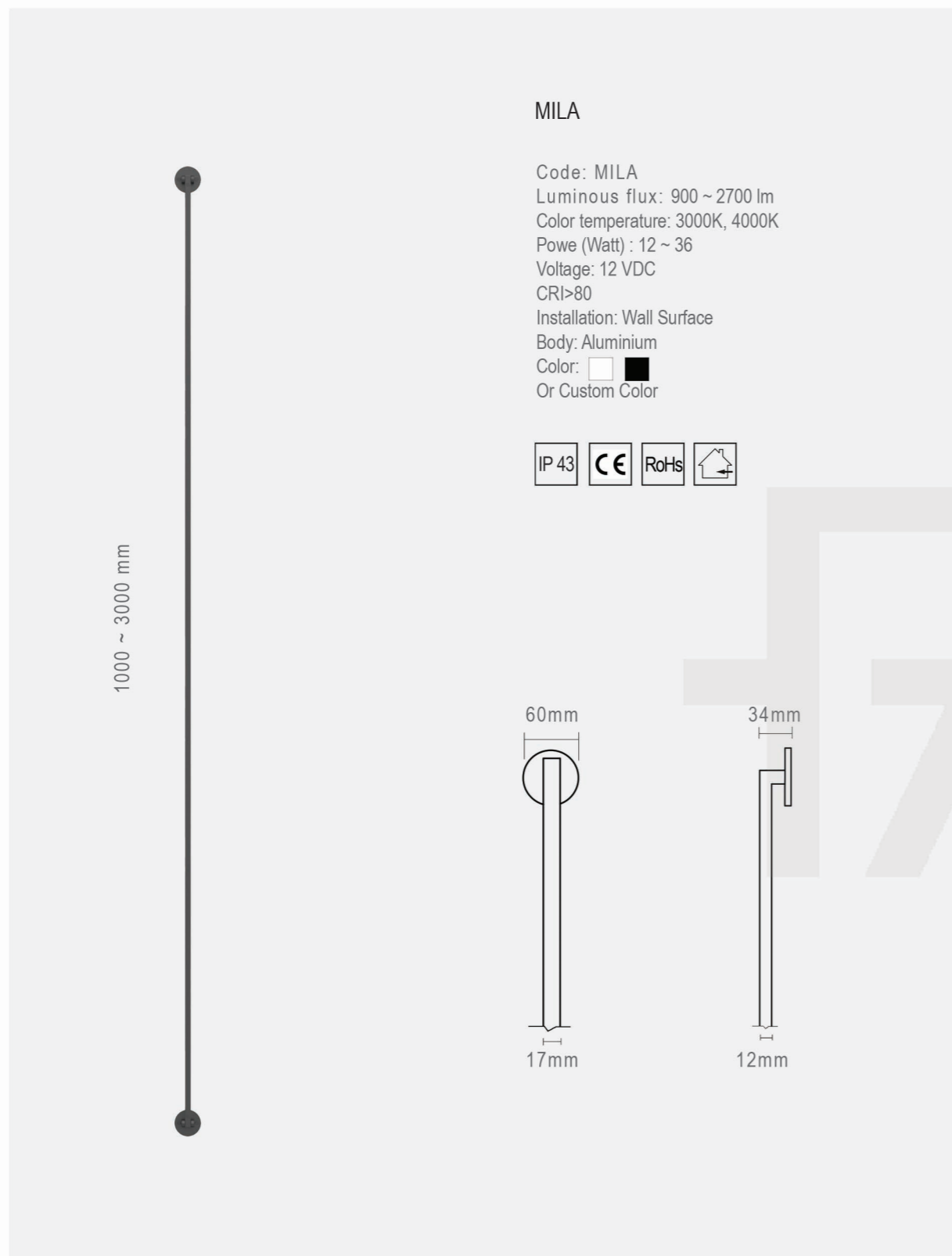



VIOLET

Code: VIOLET
Luminous flux: 2100 ~ 4200 lm
Color temperature: 3000K, 4000K
Power (Watt) : 28 ~ 56
Voltage: 220 VAC
CRI>80
Installation: Wall
Body: Polycarbonate

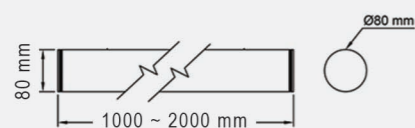



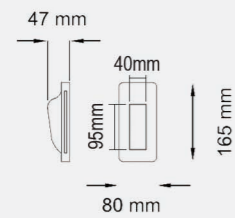

PANIZ-L-M

Code: P-L-M
Luminous flux: 220 lm
Color temperature: 3000K, 4000K
Power (Watt) : 3
Voltage: 220 VAC
Installation: Recessed
Body: Gybsum
Cut Size: \varnothing 85X170mm

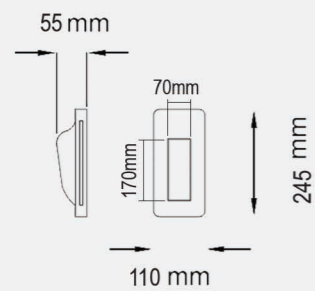

PANIZ-L-B

Code: P-L-B
Luminous flux: 220 lm
Color temperature: 3000K, 4000K
Power(Watt) : 3
Voltage: 220 VAC
Installation: Recessed
Body: Gybsum
Cut Size: \varnothing 250X115mm





www.fadco.ir

Head Office & Showroom

No.20,South Kaveh Blv, Sadr Highway, Tehran-IRAN.

Tel : +98 21 22 63 91 63

Whats App : +98 936 154 43 67

Instagram : @fadlighting