

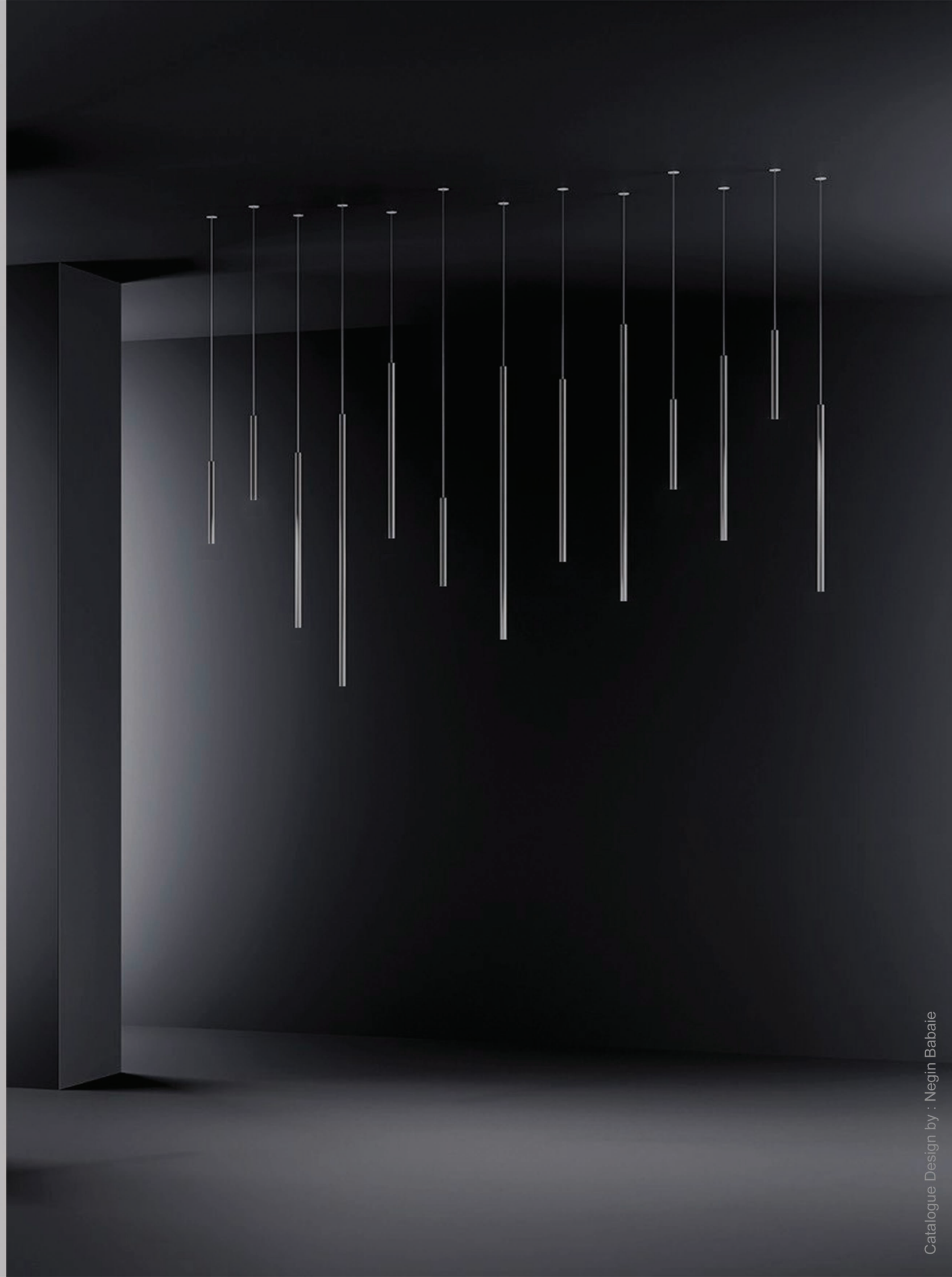

Lighting Design  
LED Lights

Since 2004

Pendant Lights Catalogue



# Contents

## PNDANT

3 LED PANEL 60\*60



3 LED PANEL 120\*30



5 PIPE LIGHT-48120



5 PIPE LIGHT-30600



7 PIPE LIGHT-50290



7 PIPE LIGHT-50600



9 PIPE LIGHT-38330



9 PIPE LIGHT-28500



11 MANIDA

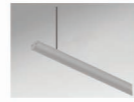

13 VIOLET



15 MATCH

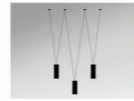

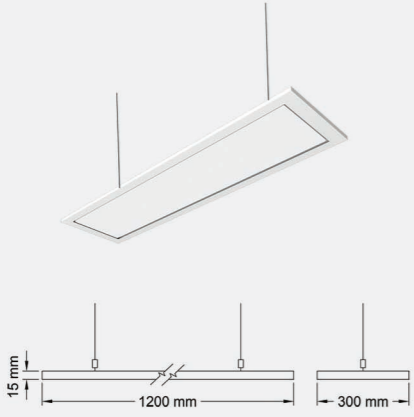

**LED PANEL-H (30X120)**

Code: LPH 30x120  
Luminous flux: 3980 lm/m  
Color temperature: 3000K, 4000K, 6000K  
Power(watt) : 48  
Voltage: 220 VAC  
CRI>80  
Installation: Pendant  
Body: Aluminum

IP 43 CE RoHS

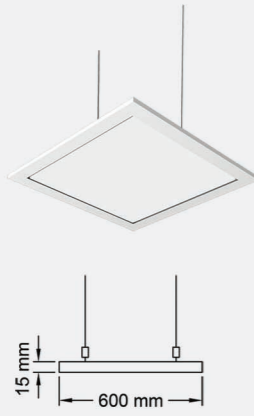

**LED PANEL-H (60X60)**

Code: LPH 60x60  
Luminous flux: 3980 lm/m  
Color temperature: 3000K, 4000K, 6000K  
Power(watt): 48  
Voltage: 220 VAC  
CRI>80  
Installation: Pendant  
Body: Aluminum

IP 43 CE RoHS



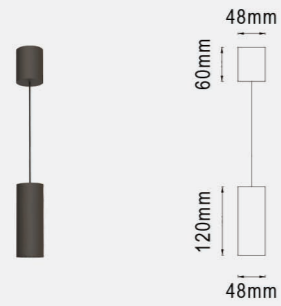

### PIPE LIGHT- 48120

Code: PL-48120  
Luminous flux: 900 lm  
Color temperature: 3000K, 4000K  
Power(watt): 10  
Voltage: 220 VAC  
CRI>90  
Installation: Pendant  
Body: Aluminium  
Body Color:

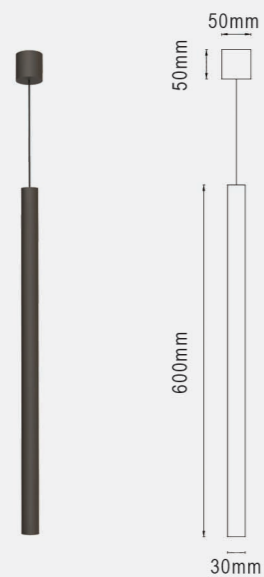

### PIPE LIGHT-30600



Code: PL-30600  
Luminous flux: 270 lm  
Color temperature: 3000K, 4000K  
Power(watt): 3  
Voltage: 220 VAC  
CRI>90  
Installation: Pendant  
Body: Aluminium  
Body Color:

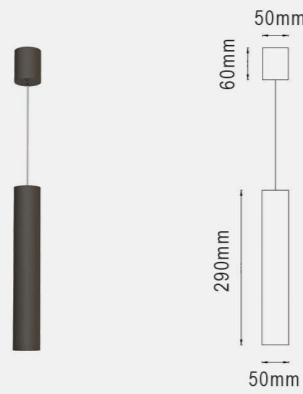



**PIPE LIGHT-50290**

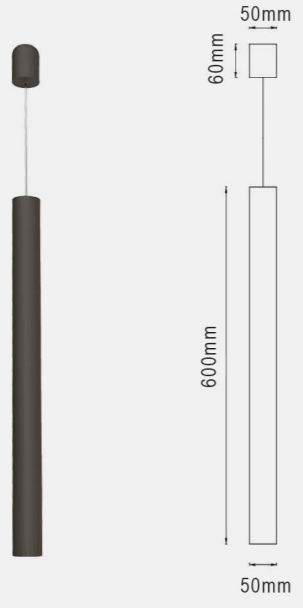

Code: PL-50290  
Luminous flux: 630 lm  
Color temperature: 3000K, 4000K  
Power(watt): 7  
Voltage: 220 VAC  
CRI>90  
Installation: Pendant  
Body: Aluminium  
Body Color:

IP20 CE RoHS  



**PIPE LIGHT-50600**

Code: PL-50600  
Luminous flux: 630 lm  
Color temperature: 3000K, 4000K  
Power(watt): 7  
Voltage: 220 VAC  
CRI>90  
Installation: Pendant  
Body: Aluminium  
Body Color:

IP20 CE RoHS  



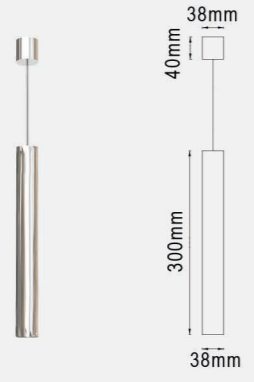

**PIPE LIGHT-38330**

Code: PL-38330  
Luminous flux: 420 lm  
Color temperature: 3000K, 4000K  
Power(watt): 5  
Voltage: 220 VAC  
CRI>90  
Installation: Pendant  
Body: Aluminium  
Body Color:

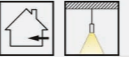
IP20 CE RoHS 



**PIPE LIGHT-28500**

Code: PL-28500  
Luminous flux: 180 lm  
Color temperature: 3000K, 4000K  
Power(watt): 3  
Voltage: 220 VAC  
CRI>90  
Installation: Pendant  
Body: Aluminium  
Body Color:

IP20 CE RoHS 



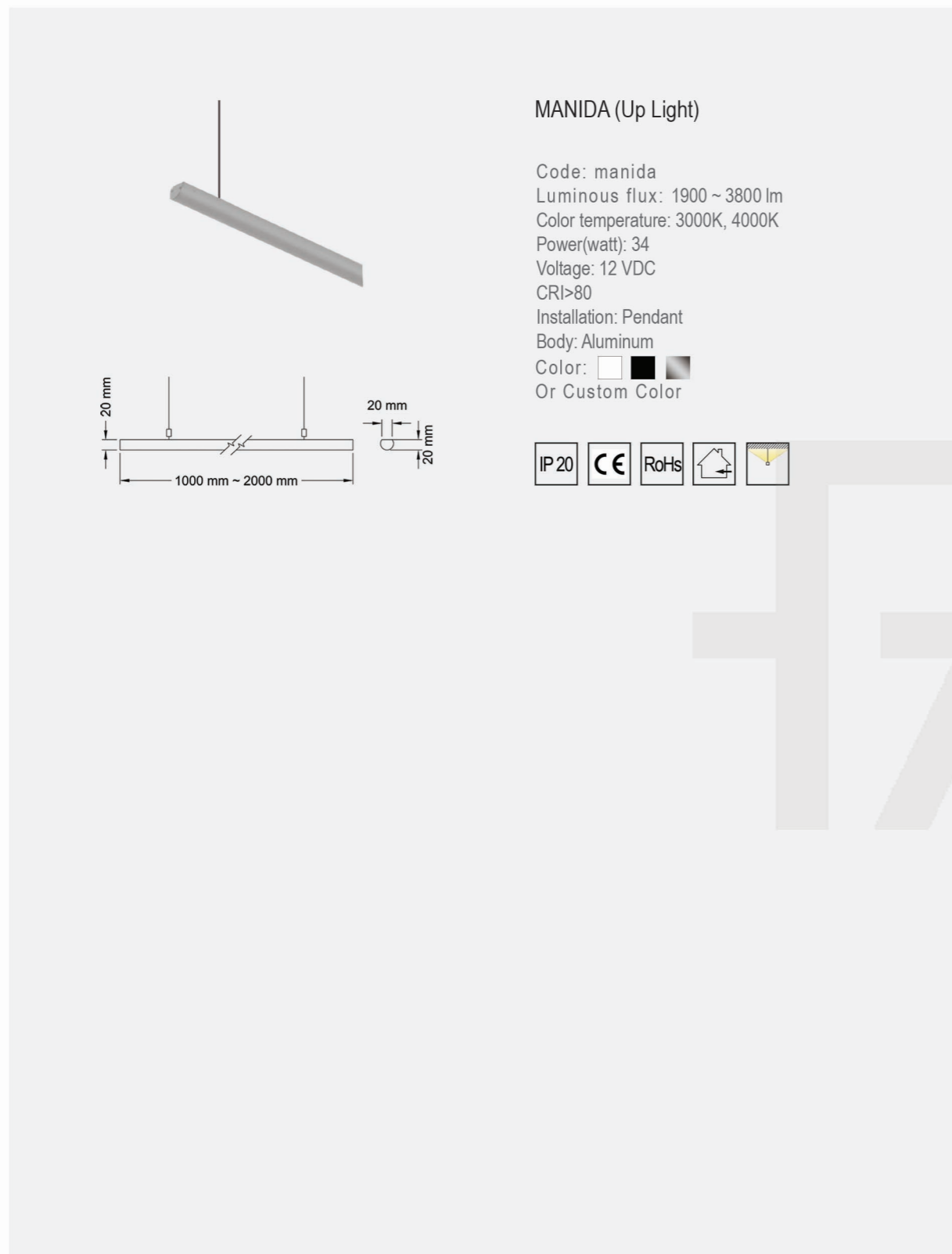

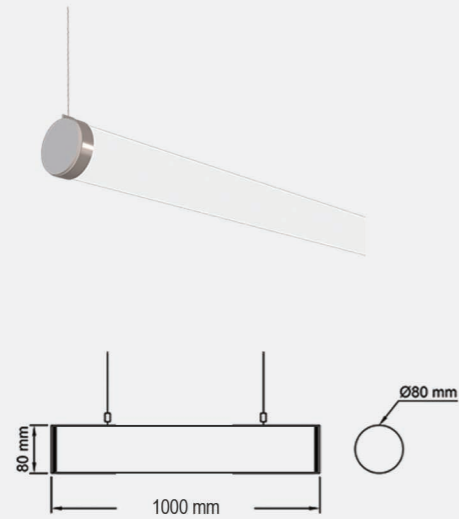

### VIOLET

Code: violet  
Luminous flux: 3600 lm  
Color temperature: 3000K, 4000K  
Power(watt): 28  
Voltage: 220 VAC  
CRI>80  
Installation: Power  
Body: Polycarbonate





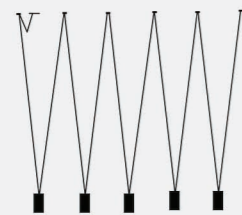
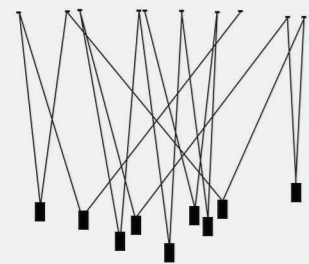
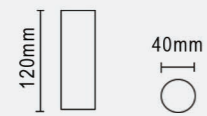

### MATCH

Code: MATCH  
Luminous flux: 400 lm (Each One)  
Color temperature: 3000K, 4000K  
Wattage: 5 W (each lamp)  
Voltage: 220 VAC  
CRI>80  
Installation: Suspended  
Body: Brass  
Color:



PERSICA



[www.fadco.ir](http://www.fadco.ir)

Head Office & Showroom

No.20,South Kaveh Blv, Sadr Highway, Tehran-IRAN.

Tel : +98 21 22 63 91 63

Whats App : +98 936 154 43 67

Instagram : @fadlighting